

# RED HAT AGILE INTEGRATION OVERVIEW

*Enabling your API-Centric Strategy*

June 10 2019

# INTEGRATION IS UNDERGOING RAPID CHANGE: HYBRID CLOUD & NEED FOR AGILITY

Traditional integration incompatible with  
hybrid cloud development

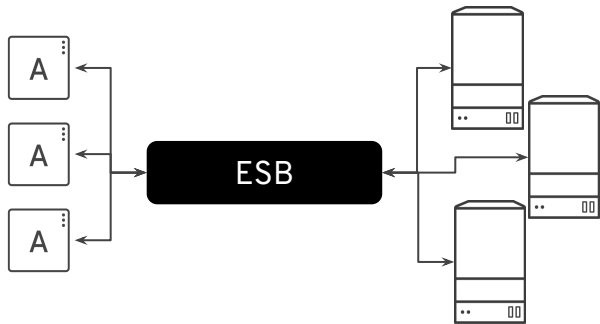

Centralize ♦ Leverage ♦ Simplify  
Internal teams ♦ Maximize use of resources

Modern architectures and app development  
requires more agile solutions



Microservices ♦ Scalability ♦ DevOps  
Agile Teams ♦ Cloud App Dev

USE INTEGRATION WHERE NEEDED, RATHER THAN  
CENTRALIZING

# INTEGRATION DELIVERY NEEDS TO CHANGE

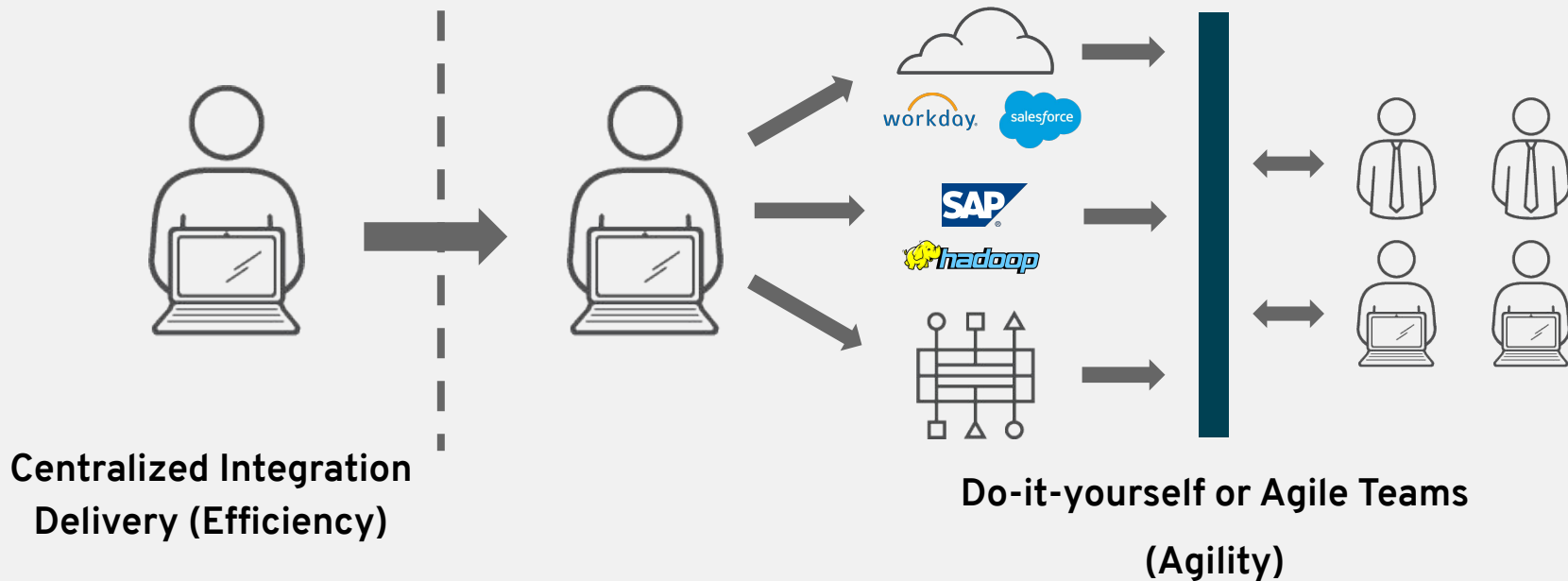

RESHAPING THE INTEGRATION DELIVERY MODEL: ENABLE DIY TEAMS

# Hybrid Development: Two Key Personas



## Citizen Integrator

- Tech / Non-Tech
- Low code approach
- High productivity
- Tactical Use Case
- Business focus



## Developer



- Definitely Tech
- Coder (Java, C#, etc.)
- IDE Tooling
- Dev/Ops
- Foundational focus

# Hybrid Development: Two Key Personas



## Citizen Integrator

- Tech / Non-Tech
- Low code approach
- High productivity
- Tactical Use Case
- Business focus

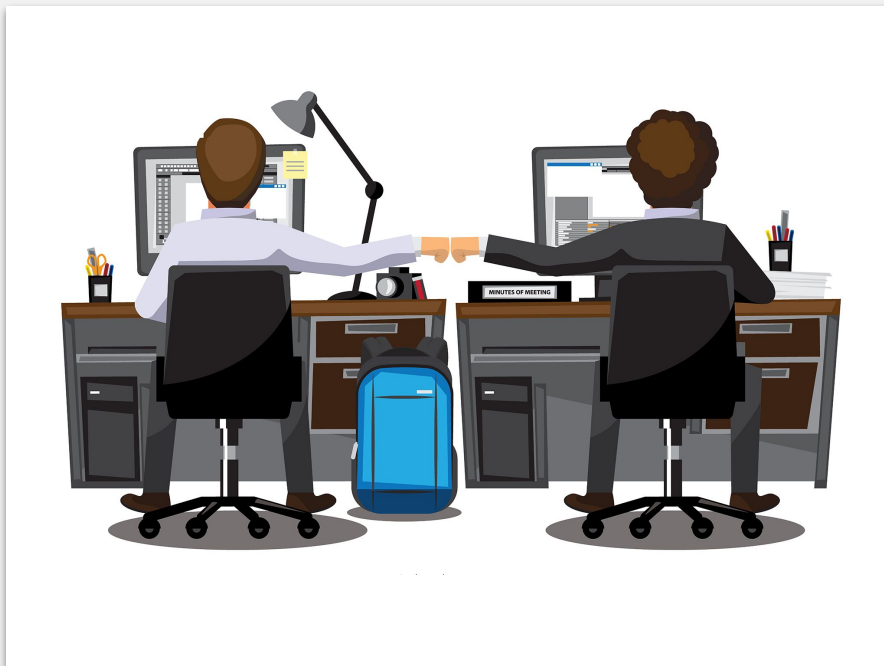

## Developer



- Definitely Tech
- Coder (Java, C#, etc.)
- IDE Tooling
- Dev/Ops
- Foundational focus

# WHAT'S NEEDED? API-CENTRIC INTEGRATION.

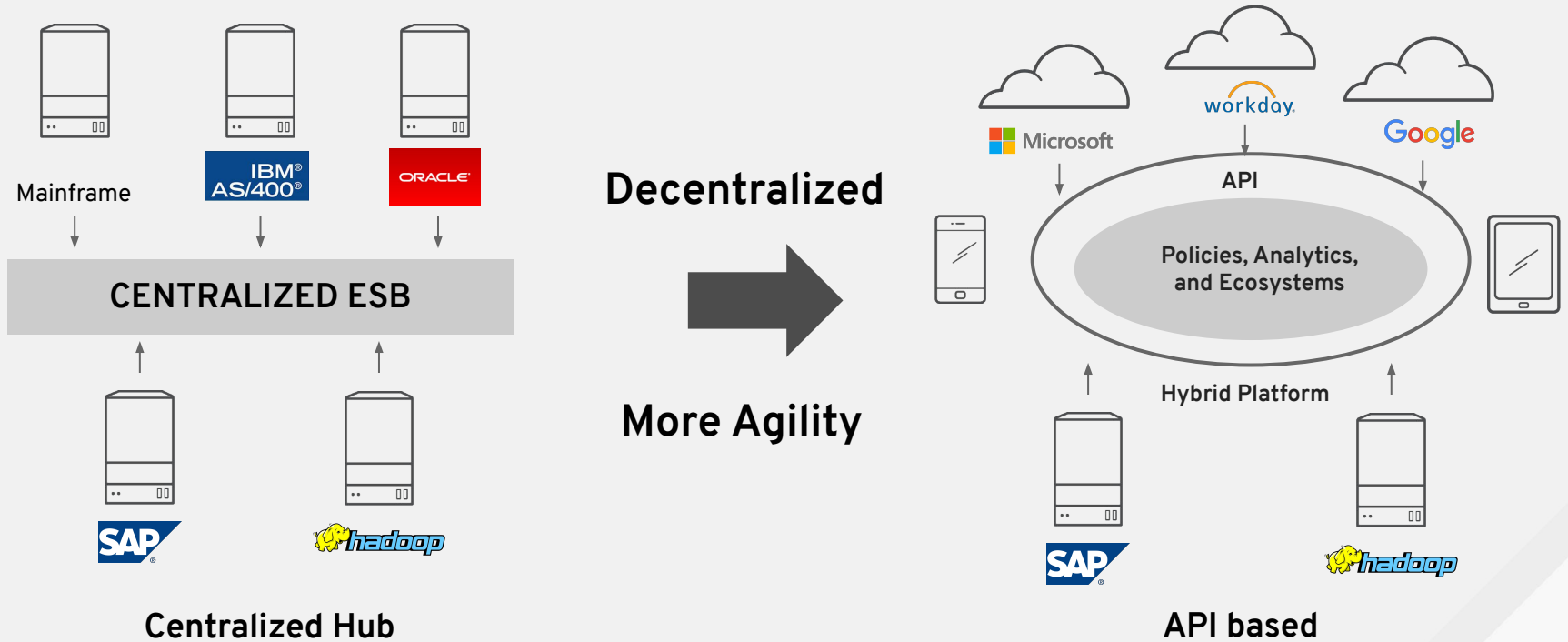

# IMPLEMENT: RED HAT FUSE

Standardized Integration Platform



For developers

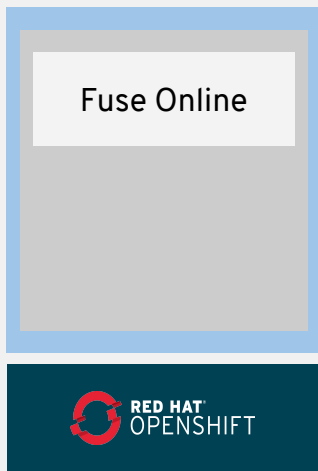

For integrators

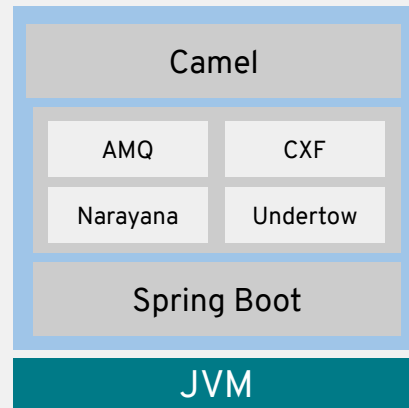
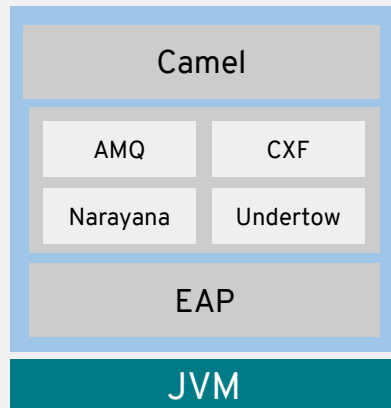
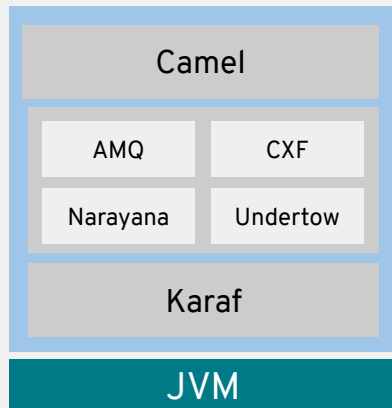

OS



OS



OS



**QUESTIONS?**